

OPTIMISATION OF FUZZY BASED MAXIMUM POWER POINT TRACKING IN PV SYSTEM FOR RAPIDLY CHANGING SOLAR IRRADIANCE

C. S. Chin, P. Neelakantan, H. P. Yoong, K. T. K. Teo

School of Engineering and Information Technology, University Malaysia Sabah, Kota Kinabalu, Malaysia
Email: cschin84@yahoo.com kenteo@ieee.org

Received January 2011, Revised March 2011, Accepted April 2011

Abstract

Solar photovoltaic (PV) electrification is an important renewable energy source. The electric which is converted directly from solar irradiation via PV panel is not steady due to different solar intensity. To maximize the PV panel output power, perturb and observe (P&O) maximum power point tracking (MPPT) has been implemented into the PV system. Through a buck-boost DC-DC converter, MPPT is able to vary the PV operating voltage and search for the maximum power that the PV panel can produce. The implementation of fuzzy logic is proposed in this paper. Based on the change of power, dp and change of power with respect to change of voltage, dp/dv , fuzzy determines the size of the perturbed voltage. In this paper, the performance of fuzzy logic with various membership functions (MFs) is tested to optimize the MPPT. Fuzzy logic can facilitate the tracking of maximum power faster and minimize the voltage variation. Simulation results show that the performance of fuzzy based MPPT with five membership functions (5MFs) is better than fuzzy based MPPT with three membership functions (3MFs), followed by the conventional P&O MPPT.

Keywords: Photovoltaic; MPPT; fuzzy logic; perturb & observe.

1. Introduction

Today the world aware of solar photovoltaic is an important renewable energy source for electricity generation especially in countries where the solar density is relatively high. Solar photovoltaic is a phenomenon where the solar irradiation is converted directly into electricity via solar cell [1] and the process does not have any materials to be consumed or emitted. Solar electrification can be applied even in rural areas where stand-alone PV system can supply adequate electricity for certain area independently without the need of having connection with utility grid.

The PV array has a particular operating point that can supply the maximum power to the load which is generally called maximum power point (MPP). The maximum power point has a non-linear locus where it varies according to the solar irradiance and the cell temperature [2]. To boost the efficiency of the PV system, the MPP has to be tracked and followed by regulating the PV panel to operate at MPP operating voltage point, thus optimizing

the production of the electricity. The optimizing process will maximize the power produced by the PV panel.

There are several methods that have been widely implemented to track the MPP. The most common methods are Perturb and Observe (P&O), incremental conductance and three-point weight comparison. In this paper, P&O MPPT is investigated. P&O technique applies perturbation to the buck-boost DC-DC controller by increasing or decreasing the pulse width modulator (PWM) duty cycle, subsequently observes the effect on the PV output power [3]. If the power at present state is larger than previous state, the controller's duty cycle shall be increased or vice-versa until the MPP operating voltage point is identified. Problem that arises in P&O MPPT method is that the operating voltage in PV panel always fluctuating due to the needs of continuous tracking for the next perturbation cycle.

In this paper, fuzzy logic is proposed to be implemented in MPPT. Fuzzy is robust and relatively simple to design since fuzzy do not require information about the exact model [4]. The PV power at the present state will be compared with the PV power at the previous state and thus the change of power will be one of the inputs of fuzzy inference system (FIS). Another fuzzy input will be the change of power with respect to the change of voltage. Based on the changes of these two inputs, fuzzy can determine the size of the perturbed voltage. Therefore, fuzzy based MPPT can track the maximum power point faster. In addition, fuzzy can minimize the voltage fluctuation after MPP has been recognized.

The inference of three membership functions (3MFs) and five membership functions (5MFs) at the inputs of FIS is carried out. It is expected having more MFs and rules will lead to longer computational time but increase the sensitivity of the changes to the fuzzy input.

2. Fuzzy logic based P&O MPPT PV system

The fuzzy based MPPT solar PV system is illustrated in Fig. 1. The system consists of a PV panel, buck-boost converter, fuzzy based MPPT control unit and a load. The power produced by PV panel is supplied to the load through a buck-boost converter. The output voltage and current from the PV panel are fed to the fuzzy based MPPT control unit to determine the perturbed voltage reference for buck-boost converter.

2.1. Mathematical model of PV panel

The general model of solar cell can be derived from physical characteristic which is usually being called as one diode model. The equivalent circuit of solar cell is shown in Fig. 2 [4]-[7]. Equation 1 shows the Shockley diode equation which describes the I - V characteristic of diode D_m ,

$$I_{D_m} = I_0 \left[\exp\left(\frac{V_{D_m}}{n V_T}\right) - 1 \right] \tag{1}$$

where I_{D_m} is the diode current, I_0 is the reverse bias saturation current, V_{D_m} is the voltage across the diode, n is ideality factor of the diode and V_T is the thermal voltage. Thermal voltage, V_T however can be defined as equation (2)

$$V_T = \frac{k T}{q} \tag{2}$$

where k is Boltzmann constant ($1.3806503 \times 10^{-23}$ J/K), T is temperature in degrees kelvin and q is electron charge ($1.60217646 \times 10^{-19}$ C).

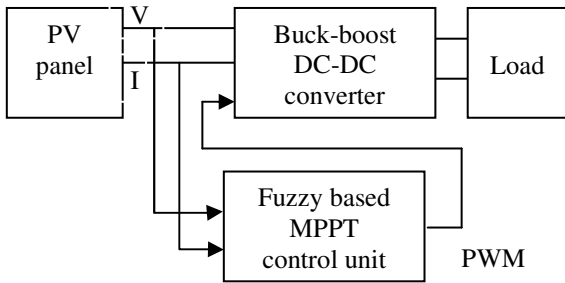

Fig. 1: Fuzzy based MPPT solar PV system.

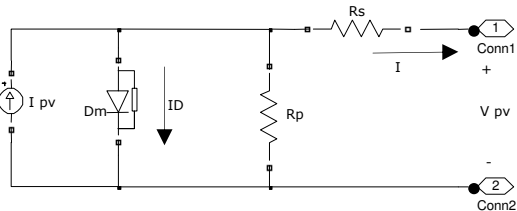

Fig. 2: Equivalent circuit for solar cell.

To model the I - V characteristic of PV array, equation (3) can be derived based on the equivalent circuit in Fig. 2,

$$I = I_{pv} - I_0 \left[\exp\left(\frac{V_{pv} + I R_s}{n V_T}\right) - 1 \right] - \frac{V_{pv} + I R_s}{R_p} \tag{3}$$

where I is the current at terminals of PV array, I_{pv} is the PV array current, V_{pv} is the PV array terminal voltage, R_s is the equivalent series resistance of the array and R_p is the equivalent parallel resistance.

Unlike the electrical generators which are generally classified as either current source or voltage source, the PV device presents hybrid behavior. PV panel acts as a current source when PV panel operates at voltage smaller than MPP voltage point but it acts as voltage source when it operates at voltage larger than MPP voltage point [8]-[9].

The I - V characteristic of the PV panel is strongly depending on the external influences such as solar irradiance level and cell temperature. The amount of solar irradiance affects the generation of charge carrier in the PV panel. The charge carrier influences the generated current from the PV panel.

In addition, the I - V characteristic of the PV panel is also depending on the internal characteristics such as the series resistance, R_s and the parallel resistance, R_p . The series resistance is the sum of structural resistance of PV panel and it has strong influence when PV panel acts as voltage source. The parallel resistance R_p has great influence when the PV panel acts as current source. R_p usually exists due to the leakage current of p-n junction, depending on the fabrication method of the PV cells. Generally, R_p is very high since high structural resistance can resist the PV cell from being short circuited. R_s on the other hand is very low as the current generated by PV panel should be directed to the load without any resistance. To model the PV array in simulation, the PV array is simplified by neglecting both R_p and R_s [10].

2.2. Buck-boost DC-DC converter

Buck-boost DC-DC converter is an important element in PV system since buck-boost converter is able to regulate the output voltage that may be less or greater than the input voltage. Buck-boost converter allow more flexibility in modulating the energy transfer from the input source to the load by varying the duty cycle, D [11]. Fig. 3 shows the circuit diagram of buck-boost DC-DC converter.

The operation of the buck-boost converter can be divided into two modes, namely “on” state and “off” state. During the “on” state the IGBT is turned on and the diode D_m is reverse biased. The current from

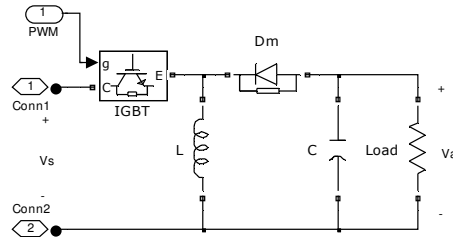

Fig. 3: Circuit diagram of buck boost converter.

the input source flows through the inductor L . When IGBT is turned off during “off” state, the energy stored in the inductor L will be transferred to the load until the next “on” state. By varying the duty cycle, D , the output voltage is changed accordingly. The duty cycle, D however can be delivered by MPPT control unit.

In buck-boost converter, the output polarity is opposite to the input polarity. Fig. 4 shows the operation of buck-boost converter. The relationship among the load voltage, V_a , input source voltage, V_s and duty cycle, D can be described as equation (4).

$$D = \frac{V_a}{V_a - V_s} \tag{4}$$

2.3. Perturb and observe MPPT

Perturb and Observe (P&O) MPPT has been used to track the MPP by continuously changing the operating voltage point of solar panel. This method applies a little increase or decrease in operating voltage to the panel and compare the PV output power at the present and the previous perturbation cycle [12]-[14]. Fig. 5 shows the operation of P&O MPPT.

The operation of P&O MPPT is started with the measurement of voltage, V and current, I . The process is continued with the comparison of these two parameters between the actual state, k and the previous state, $k - 1$.

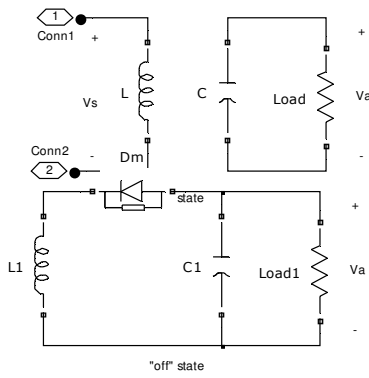

Fig. 4: The operation of buck-boost converter.

There are total of four cases to be considered in P&O MPPT. Fig. 6 is the power-voltage characteristic of PV panel for the four cases under discussion. The P - V characteristic is obtained as shown in Fig. 6 when the PV module is operated at $600W/m^2$ solar irradiance at cell temperature $25^\circ C$.

Case I where $P_k > P_{k-1}$ and $V_k > V_{k-1}$, the situation can be described as path α in Fig. 6. It can be noticed that the PV power is increased as the increasing of the PV operating voltage. Therefore, a small perturbed voltage, ΔV need to be added to the present PV voltage in order to approach MPP operating voltage.

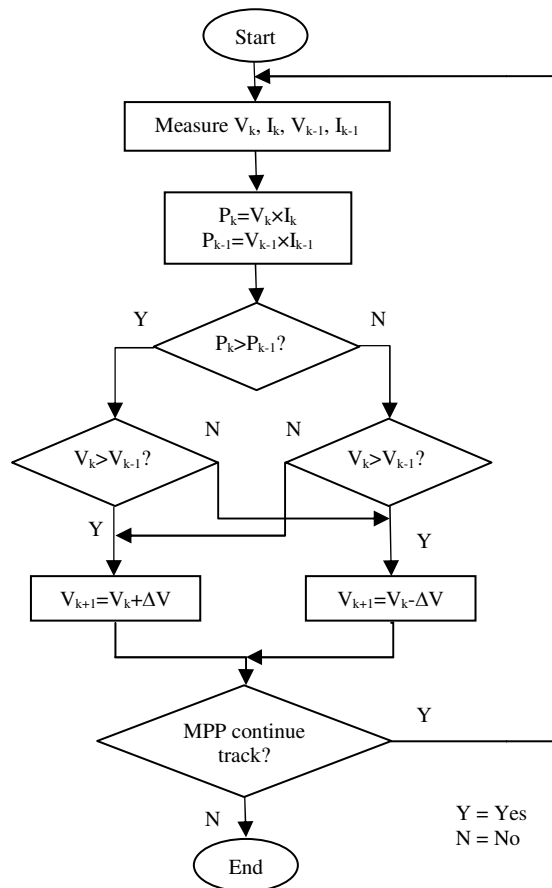

Fig. 5: Flowchart of P&O MPPT.

Case II where $P_k > P_{k-1}$ and $V_k < V_{k-1}$ can be illustrated as path β in Fig. 6. When the operating voltage is decreased, the PV power is increasing. Thus, it should have reduction of ΔV on the present voltage. The process of reduction ΔV will be continue until the MPP operating voltage point is tracked or the situation is switched to other cases.

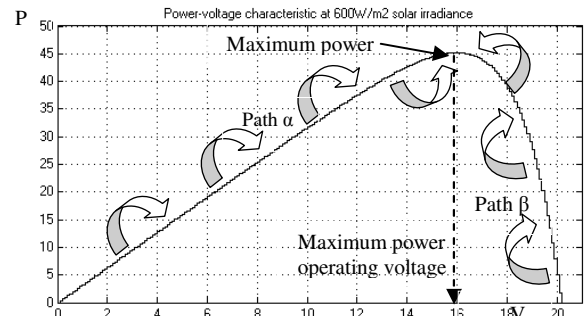

Fig. 6: Principle for MPP tracking.

Case III where $P_k < P_{k-1}$ and $V_k > V_{k-1}$ can be referred to the path β in Fig. 6. Case III illustrates the PV power is decreased as the increment of PV operating voltage. Therefore, it should have a reduction of ΔV on the present PV operating voltage.

In case IV, the situation $P_k < P_{k-1}$ and $V_k < V_{k-1}$ can be illustrated as path α in Fig. 6. In this case, the PV power is reduced as the decrement of PV operating voltage. As a result, an additional perturbed voltage ΔV will be added to the current PV operating voltage, V_k .

A common problem that arises in P&O MPPT algorithm is the PV array operating voltage being perturbed every cycle [13]. In general, the tracking of MPP will never be ended unless the PV system is stopped for operation. Even if the MPP is reached, P&O MPPT is still continually changing the operating voltage for the PV module, hoping the next cycle has greater output power. The oscillation of the operating voltage has caused the power loss in the PV system. Thus, the implementation of fuzzy logic is expected to reduce the oscillation of the operating voltage and hence minimize the power loss in the PV system.

2.4 Fuzzy logic

Fuzzy logic has been introduced in MPP tracking in the PV system lately [5]. Fuzzy logic is easy to use due to their heuristic nature associated with simplicity and effectiveness for linear and non-linear systems. Among the advantages are fuzzy does not need accurate mathematical model; fuzzy can work with imprecise inputs; fuzzy can deal with non-linearity; and fuzzy are more robust than conventional non-linear controller [15].

The operation of fuzzy logic control can be classified into four basic elements, namely fuzzification, rule base, inference engine and defuzzification as shown in Fig. 7.

The fuzzification is the process of converting the system actual value λ and δ into linguistic fuzzy sets using fuzzy membership function. The membership function is a curvature that describes each point of membership value in the input space. Fuzzy rule base is a collection of if-then rules that contain all the information for the controlled parameters [16]. It is set according to professional experience and the operation of the system control. Fuzzy inference engine is an operating method that formulates a logical decision based on the fuzzy rule setting and transforms the fuzzy rule base into fuzzy linguistic output. Defuzzifier is a manner to convert the linguistic fuzzy sets back into actual value γ .

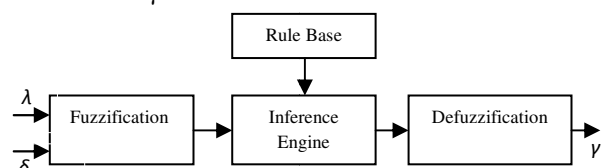

Fig. 7: Basic elements in fuzzy logic controller.

3. Modeling and simulation

The characteristics of SHARP NE-80E2EA multi-crystalline silicon PV module with 80W have been studied and modeled in MATLAB SIMULINK. P&O MPPT has been designed to track the maximum power operating voltage of the PV panel. In order to track the MPP more effectively, fuzzy logic is implemented to assist the P&O MPPT.

3.1 PV panel

The SHARP NE-80E2EA is modeled in MATLAB-SIMULINK using equation (3) with the assumption that the PV module has constant temperature of 25°C. Since R_s is very small and R_p is very high, it can be assumed that I_{pv} is equal to PV panel short circuit current, I_{sc} .

The parameters obtained from SHARP NE-80E2EA datasheet for PV panel modeling are shown in Table 1. Fig. 8 shows the P - V characteristic of the PV panel at different solar irradiance level but at constant cell temperature of 25°C. It can be noticed that the MPP operating voltage point of PV panel varies at different solar irradiance. As the solar irradiance increased, the PV MPP operating voltage is higher. Fig. 9 shows the P - V characteristic of PV panel at 600W/m² solar irradiance and the corresponding I - V curve.

The modeling of PV panel in MATLAB-SIMULINK has the similar characteristics that described in SHARP NE-80E2EA datasheet.

3.2 Fuzzy logic based MPPT

Fuzzy logic is implemented to assist the conventional P&O MPPT to obtain the MPP operating voltage point faster and have more stable PV output power. Many researchers are investigating the implementation of fuzzy logic into MPPT for the PV generated power optimisation.

power and change of PV current whereas the output is the converter current reference. In [8], the two inputs of fuzzy controller are dp/dv and the previous duty cycle, D_{k-1} . The fuzzy decides the output duty cycle, D_k based on the fuzzy inputs. In [10], fuzzy works by tuning the duty cycle according to voltage error and change of voltage error.

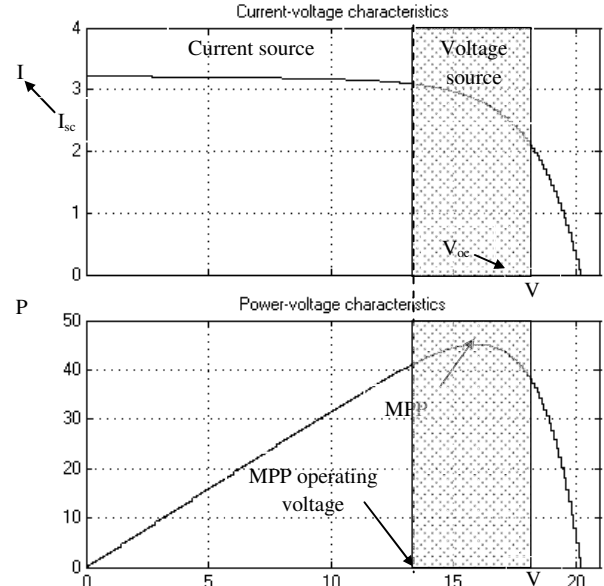

Fig. 9: Current-voltage characteristic and power-voltage characteristic of PV panel at 600W/m².

In this paper, change of power, dp and change of power with respect to change of voltage, dp/dv have been selected as the inputs of the fuzzy controller where dp and dp/dv can be described as in equation (5) and equation (6) respectively.

$$dp = P_k - P_{k-1} \tag{5}$$

$$\frac{dp}{dv} = \frac{P_k - P_{k-1}}{V_k - V_{k-1}} \tag{6}$$

where k is the current state and $k - 1$ is the previous state. Based on these two inputs, fuzzy will decide the size of perturbed voltage cv to P&O MPPT for further process.

The membership function of input dp is set to have range of [0 2] and the range of input dp/dv is [0 5]. The range of fuzzy output cv is set to [0 2.5]. In this paper, fuzzy works according to the magnitude of the inputs and decides the magnitude of the output for P&O MPPT.

Introduction of fuzzy logic control in P&O MPPT has been investigated with three membership functions (3MFs) and five membership functions (5MFs) for both inputs dp and dp/dv . Fig. 10 shows the arrangement of 5MFs of the fuzzy inputs whereas Fig. 11 displays the fuzzy output cv of 3MFs and 5MFs fuzzy logic.

It is noticed that the membership function is not distribute evenly along the universe of discourse. The fuzzy output cv shown in Fig. 11(a) has four MFs at the range of [0 0.72] and three MFs at the range of [0.65 2.5]. In the case of fuzzy input 5MFs, the arrangement of MF at the output is eight MFs at the range of [0 0.69] and four MFs at the range of [0.63 2.5]. More membership functions been set to the fuzzy output cv at the range of [0 0.7] due to fuzzy is needed to work more sensitive at this range.

Membership function is the curvature describing each point of membership value. More membership functions set in [0 0.7] means that more rules can be implemented which can lead to

Table 1: Parameters of SHARP NE-80E2EA PV array at 25°C and 1000W/m² solar irradiance

Parameters	Symbol	Typical value
Open circuit voltage	V_{oc}	21.3V
Maximum power voltage	V_{pm}	17.1V
Short circuit current	I_{sc}	5.16A
Maximum power current	I_{pm}	4.68A
Maximum power	P_m	80W
No. of cells	-	36

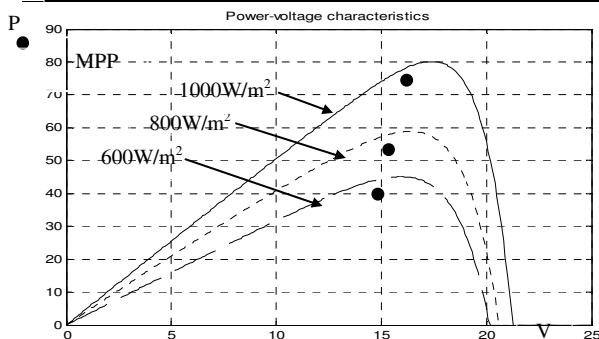

Fig. 8: Power-voltage characteristic of PV panel at different solar irradiance.

In [1], [3] and [5], the derivative dp/dv and change of dp/dv become the inputs of fuzzy controller for duty cycle tuning. In [2], the author selected the change of power and change of voltage as the inputs and a voltage reference as the output of fuzzy controller. The inputs of fuzzy in [4] are change of PV

more specific output. Each of the membership function holds a more specific range and responds sensitively to the precise environment. This application is important especially when the maximum power operating point of PV panel has been successfully tracked. Due to the requirements of continuously tracking for the next MPP, a minimal perturbed voltage has to be applied to the PV operating voltage. Hence, the voltage fluctuation of PV panel can be minimized when the MPP has been tracked.

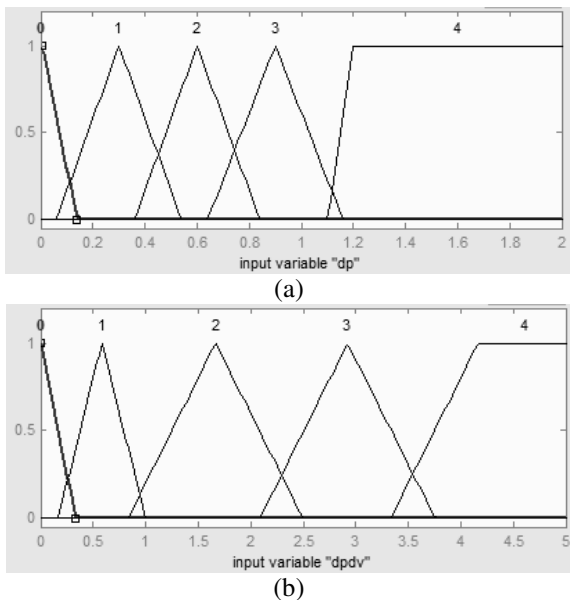

Fig. 10: Fuzzy logic with 5MFs in (a) input dp and (b) input variable dp/dv .

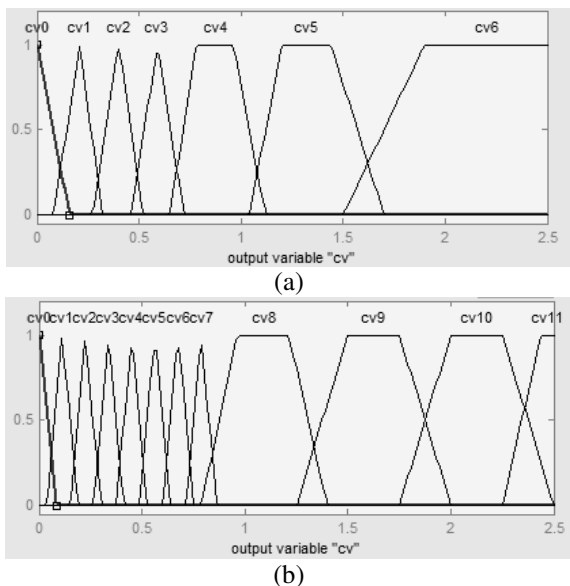

Fig. 11: Fuzzy logic output cv of (a) 3MFs fuzzy control and (b) 5MFs fuzzy control.

There are less membership function set at the range of large perturbed voltage at about [0.7 2.5] in fuzzy output cv . This is because large perturbed voltage leads to the fast tracking of MPP. Fuzzy rule base is an important element in fuzzy logic controller. Fuzzy rule base collects all the data which the fuzzy inference engine will determine a logical conclusion based on the collected data. Fuzzy viewer is a tool to verify if the rules are set properly which can be shown in Fig. 12. Each row of plot in fuzzy viewer represents one rule.

Fig. 12 shows the fuzzy viewer for the fuzzy logic with 5MFs. The fuzzy is set to have 19 rules and hence there are 19 rows in rule viewer. Row 15 in Fig. 12 declares that if the change of power is very low, regardless of the dp/dv , the perturbed voltage reference is set to be the lowest. The output decision of fuzzy can be checked via adjusting index line of fuzzy inputs. Fig. 12 shows the index line of input dp has been adjusted to 0.8 and the index line of input cv is set to 2.3. Through fuzzy inference engine calculation, the output perturbed voltage is 0.462V. Subsequently, the output cv can be checked to validate the tuning parameter.

The defuzzification method used in fuzzy based MPPT is centroid, which computes the centre of arc under curve. From Fig. 12, the areas of row 4, 5, 8 and 9 are accumulated and the area under the curve is computed as 0.462.

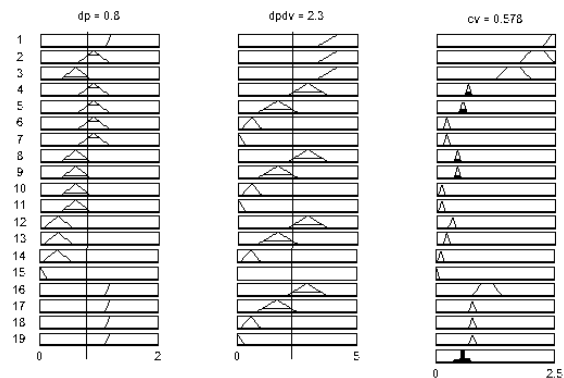

Fig. 12: Rule viewer of FIS (Fuzzy input with 5MFs).

4. Simulation results

Fig. 13, Fig. 14 and Fig. 15 shows the simulation results of PV operating voltage and PV power at solar radiance level 800 W/m^2 and at cell temperature 25°C for conventional P&O MPPT algorithm, fuzzy logic with 3MFs P&O MPPT and fuzzy logic with 5MFs P&O MPPT respectively. Fig. 16, Fig. 17 and Fig. 18 are the results of PV operating voltage and PV power of conventional P&O MPPT algorithm, fuzzy logic with 3MFs P&O MPPT and fuzzy logic with 5MFs P&O MPPT when the controllers are tested under variable solar irradiance level but at constant cell temperature of 25°C .

5. Discussion

The performances of conventional P&O MPPT and fuzzy based P&O MPPT have been examined at fixed solar radiance of 800 W/m^2 as well as the variable solar irradiance. Besides, the fuzzy logic has been revised internally, where the performance of fuzzy logic control has been compared among 3MFs and 5MFs in both inputs change of power and change of power with respect to change of voltage.

By comparing Fig. 13 and Fig. 14 under constant solar radiation test, it can be noticed that fuzzy can track the maximum power operating point faster. Based on the results, fuzzy logic control can track the MPP operating point at 6s compared to the conventional P&O MPPT tracked the MPP operating voltage at 8s. In the view of power stabilization, the PV power which is controlled by fuzzy logic is more stable than the conventional P&O MPPT. Fig. 14 shows that the fuzzy controlled PV power is fluctuated when the MPP operating voltage is identified at 6s, but as the time going on, the PV power will become more stable and reaches a steady PV power at about 11s. The conventional P&O MPPT however perform a fluctuated PV power even after the MPP operating voltage has been successfully tracked. This is due to fuzzy logic control is able to reduce the perturbed voltage

after the MPP operating voltage is identified but the conventional P&O MPPT is still performing the same size of perturbed voltage. Therefore, fuzzy based P&O MPPT has a better performance as compared to the conventional P&O MPPT

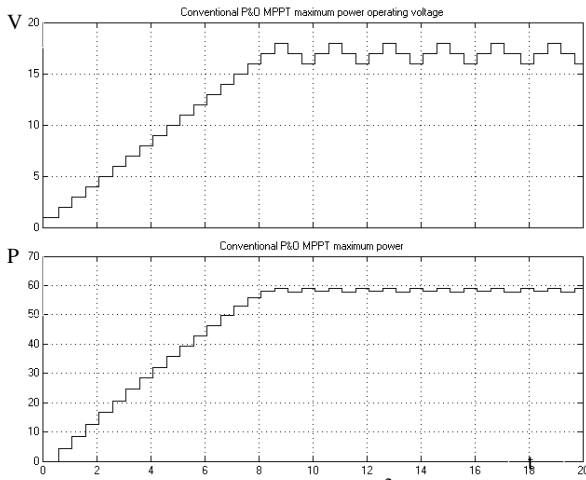

Fig. 13: Fixed solar irradiance 800 W/m² test on the conventional P&O MPPT.

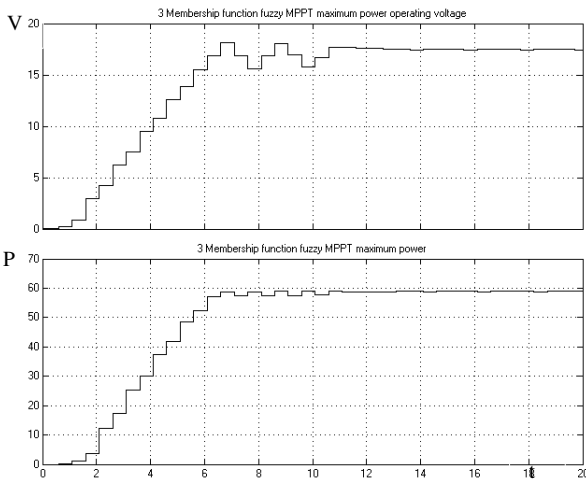

Fig. 14: Fixed solar irradiance 800 W/m² test on 3MFs fuzzy logic based P&O MPPT.

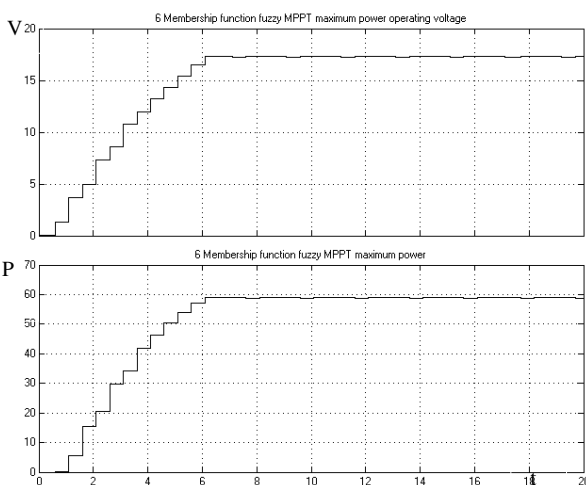

Fig. 15: Fixed solar irradiance 800 W/m² test on 5MFs fuzzy logic based P&O MPPT.

The results of constant solar testing on fuzzy logic with 3MFs and fuzzy logic with 5MFs have been compared. Based on Fig. 14 and Fig. 15, it is observed that the five membership functions

fuzzy logic is able to control the PV panel to have a more stable PV power. The fuzzy logic with 3MFs performs a small power oscillation initially after the MPP has been identified at time 6s. Fuzzy logic with 3MFs requires 5s to control the PV system to reach steady power. Fuzzy logic with 5MFs however is able to control to have a stable PV power once the MPP operating voltage has been identified. In Fig. 15, it shows that the MPP is identified at time about 6s and subsequently, the PV power reaches a steady state value without fluctuated. Therefore, the 5MFs fuzzy logic control has better performance as compared to the 3MFs fuzzy logic control.

The conventional P&O MPPT, the fuzzy logic with 3MFs P&O MPPT and the fuzzy logic with 5MFs P&O MPPT have been tested on variable solar irradiance level. The results of the three controllers are shown as in Fig. 16, Fig. 17 and Fig. 18 respectively. It can be observed from the results that the three controllers are able to track the MPP operating voltage. However, the 5MFs and 3MFs fuzzy logic P&O MPPT can track the MPP faster than conventional P&O MPPT. In the context of power stabilization, the 5MFs fuzzy logic control shows a better result followed by the 3MFs fuzzy logic P&O MPPT and finally the conventional P&O MPPT. It can be noticed that the overall PV power controlled by 5MFs fuzzy control is more stable. 3MFs fuzzy control is also producing a stable PV power, but the power fluctuation occurs from 18s to 24s and 52s to 56s. The conventional P&O MPPT however has power fluctuation from time to time.

Fuzzy logic is able to reduce the perturbed voltage after the PV MPP has been approached. The conventional P&O MPPT however do not have the ability to reduce the perturbed voltage as shown in Fig. 16. It can be seen that the operating voltage of PV system controlled by conventional P&O MPPT is fluctuated around the MPP operating voltage.

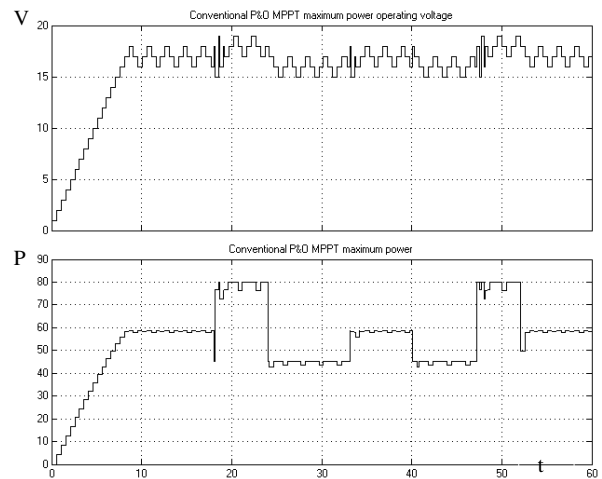

Fig. 16: Variable solar irradiance test on the conventional P&O MPPT.

Referring to Fig. 17, the 3MFs fuzzy control produce voltage fluctuation around MPP operating voltage initially after the MPP has been identified at time 7s, 18s, 40 s and 53s.

However, 3MFs fuzzy control is able to reduce the size of perturbed voltage and subsequently instruct the P&O MPPT to control the PV power not to fluctuate heavily. However, Fig. 18 shows that the 5MFs fuzzy logic control has the least voltage fluctuation around MPP operating point. From the observation of Fig. 16, Fig. 17 and Fig. 18, it can be stated that the 5MFs fuzzy logic P&O MPPT has better performance than the 3MFs fuzzy logic P&O MPPT and the conventional P&O MPPT. The five

membership function fuzzy logic P&O MPPT can track the MPP faster and control the PV system to achieve better performance in term of power stability.

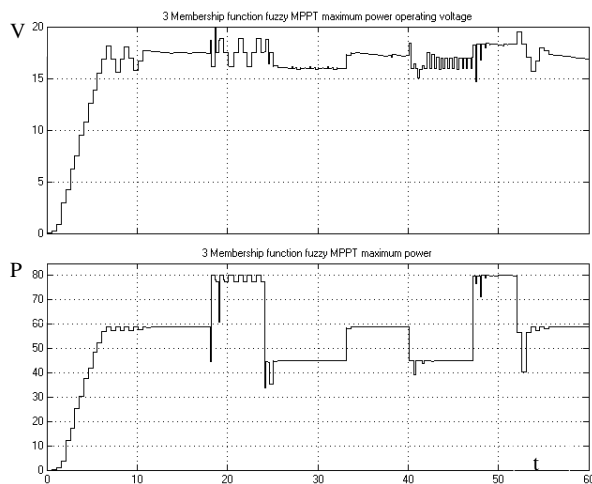

Fig. 17: Variable solar irradiance test on 3MFs fuzzy logic based P&O MPPT.

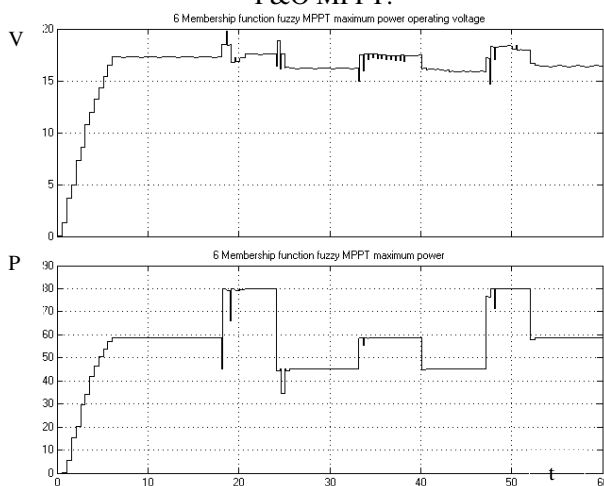

Fig. 18: Variable solar irradiance test on 5MFs fuzzy logic based P&O MPPT.

6. Conclusion

This paper presents the comparison of 5MFs fuzzy based P&O MPPT, 3MFs fuzzy based P&O MPPT and conventional P&O MPPT. The P - V characteristic and I - V characteristic of SHARP NE-80E2EA have been modeled in MATLAB-SIMULINK to examine the performance of the controllers. Based on the simulation results, it can be concluded that the controllers can assist PV panel to deliver maximum power. However, the performance of fuzzy MPPT is better than the conventional P&O MPPT. Fuzzy MPPT can track MPP faster than conventional MPPT even in variable changes of solar irradiance. In addition, fuzzy MPPT has the capability of reducing the perturbed voltage when MPP has been recognized. This action directly preserves a more stable output power compared to the conventional MPPT where the output power fluctuates due to larger perturbed voltage around MPP voltage point. Among the fuzzy logic control, the 5MFs fuzzy logic control performs better than 3MFs fuzzy logic control.

References

[1] Noppadol Khaehintung, Phaophak Sirisuk, and Anatawat Kunakorn, "Grid-connected photovoltaic system with maximum power point tracking using self-organizing fuzzy

- logic controller", IEEE Power Electronics and Drives Systems, PEDS, Kuala Lumpur, 2005, pp. 517-521.
- [2] S. Lalouni, D. Rekioua, T. Rekioua, and E. Matagne, "Fuzzy logic control of stand-alone photovoltaic system with battery storage", Journal of Power Sources, Volume 193, Issue 2, 5 September 2009, pp. 899-907.
- [3] M. S. Ait Cheikh, C. Larbes, G. F. Tchoketch Kebir, and A. Zerguerras, "Maximum power point tracking using a fuzzy logic control scheme", Revue des energies Renouvelables, Vol. 10, 2007, pp. 387-395.
- [4] Subiyanto, Azah Mohamed, M. A. Hanan, and Hamimi Fadzati Adb Wahab, "Photovoltaic maximum power point tracking using fuzzy logic controller", Proceeding of the Regional Engineering Postgraduate Conference, 2009, pp. Elec15-1-Elec15-8.
- [5] Wang Chang-Chun, Wu Ming-Chuan, and Ou Sheng-Yuan, "Analysis and research on maximum power point tracking of photovoltaic array with fuzzy logic control and three point weight comparison method", Science China Press and Springer-Verlag Berlin Heidelberg, Vol. 53, August 2010, pp.2183-2189.
- [6] Huan-Liang Tsai, Ci-Siang Tu, and Yi-Jie Su, "Development of Generalized Photovoltaic Model Using MATLAB/SIMULINK", Proceedings of the World Congress on Engineering and Computer Science, 2008.
- [7] Huan-Liang Tsai, "Insolation-oriented model of photovoltaic module using MATLAB/SIMULINK", Solar Energy 84, 2010, pp.1318-1326.
- [8] M. G. Villalva, J. R. Gazoli, and E. Ruppert F., "Modeling and circuit-based simulation of photovoltaic arrays", Brazilian Journal of Power Electronics, Vol. 14, 2009, pp. 35-41.
- [9] Jose Antonio Barros Vieira, and Alexandre Manuel Mota, "Maximum power point tracker applied in batteries charging with PV panels", IEEE International symposium on Industrial Electronics, 2008, pp. 202-207.
- [10] Marcello Gradella Villalva, Jonas Rafael Gazali, and Ernesto Ruppert Filho, "Comprehensive approach to modeling and simulation of photovoltaic array", IEEE Transaction of Power Electronics, Vol. 24, no. 5, 2009, pp. 1198-1208.
- [11] Dimosthenis Pefitsis, Georgios Adamidis, Panagiotis Bakas, and Anastasios Balouktsis, "Photovoltaic system MPPTTracker Investigation and implementation using DSP engine and buck-boost DC-DC converter", IEEE Power Electronics and Motion Control Conference, 13th EPE-PEMC, 2008, pp. 1840-1846.
- [12] A. Chouder, F. Guijoan, and S. Silvestre, "Simulation of fuzzy based tracker and performance comparison with perturb and observe method", Revue des energies Renouvelables, Vol.11, 2008, pp. 577-586
- [13] Roberto Faranda, and Sonia Leva, "Energy comparison of MPPT techniques for PV systems", WSEA transactions on Power Systems, 2008, pp. 446-455
- [14] V. Salas, E. Olias, A. Barrado, and A. Lazaro, "Review of the maximum power point tracking algorithms for stand-alone photovoltaic systems", Solar Energy Materials & Solar Cells 90, 2006, pp. 1555-1578.
- [15] Mummadi Veerachary, Tomonobu Senjyu, and Katsumi Uezato, "Feedforward maximum power point tracking of PV systems using fuzzy controller", IEEE transactions on Aerospace and Electronics Systems, Vol. 38, Issue 3, 2002, pp. 969-981.

- [16] Adel Mellit and Soteris A. Kalogirou, "Artificial intelligence techniques for photovoltaic application: A review", *Progress in Energy and Combustion Science* 34, 2008, pp. 574-632.